

ASSEMBLY INSTRUCTIONS

Description: Mercer End Table



Important safety instructions:

- Please carefully read all instructions before assembling the chair.
- For your safety and ease, assembly by two or more adults is recommended.
- Keep instructions for future use.





Pre-assembly:

- Do not discard any contents until after assembly is complete to avoid accidentally discarding small parts or hardware.
- Remove all parts and hardware from box along with any plastic protective packaging.

Parts List

Item	Description	QTY
A	Top Panel 	1
B	Metal Base 	1

Hardware List

Item	Description	QTY
a	Bolt Ø1/4"x3/4" 	4
b	Spring Washer Ø1/4" 	4
c	Flat Washer Ø1/4" 	4
d	Allen Wrench 5mm 	1
e	Clear Plastic Pad 	4

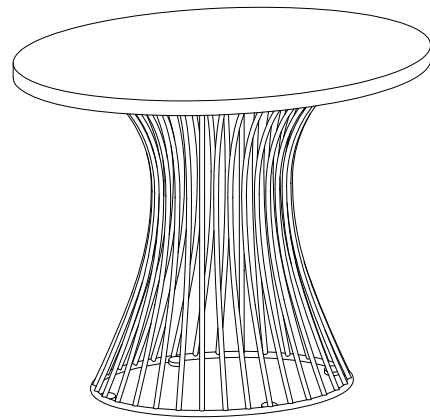

Assembly Procedures:

1. Turn the table top upside down on a flat, soft surface such as a carpet or cloth to prevent scratching the finish.
 - 1) Attach the metal base (B) to the top panel (A) using bolt (a), spring washer (b) and flat washer (c) as shown below. Securely tighten all bolts by Allen wrench (d), but do not over tighten.
 - 2) place the clear plastic pad (e) on the bottom of base (B) as shown below.

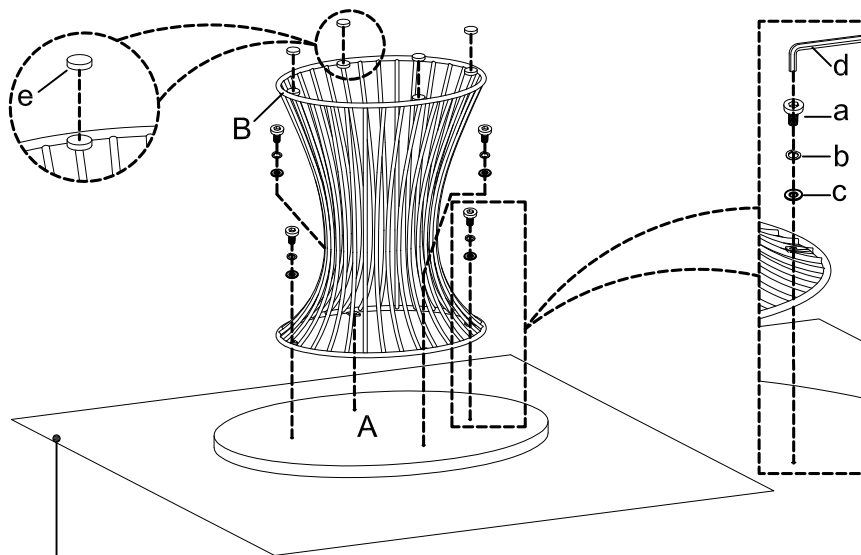

soft surface such as a carpet or cloth to prevent scratching the finish.